

Name: _____

Address: _____

Liner Pattern: _____

Retrofit step with _____ benches (indicate quantity)

Note: step location and bench positions to be indicated on drawing along with top riser height.

POOL SHAPE

- Rectangle
- True Oval
- Grecian (see wrk sheet)
- Full-L (see wrk sheet)
- Lazy-L (see wrk sheet)
- Roman (see wrk sheet)
- Other (see drawing)

BEAD STYLE

- Standard
 - "J" Hook
 - Overlap
 - Horizontal O/L
 - Vertical O/L
- O/L Size: _____

CORNERS

- Radius
- Diagonal
- 90°

Size: _____

STEPS / BENCHES

- None
- Fiberglass (straight)
- Fiberglass (curved)
- Vinyl (see worksheet)

CHECK LIST

- Length dims add up
- Width dims add up
- Depth given
- Wall height given
- Pool checked for square
- Pool shape selected
- Corner type selected
- Corner dim. given
- Liner pattern given
- Step/seam located
- Worksheet attached

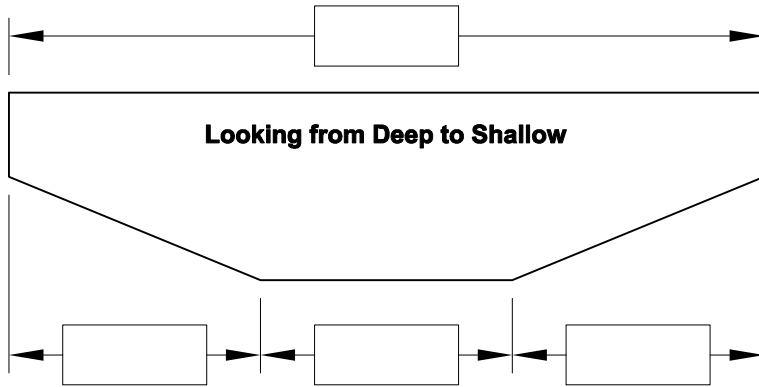
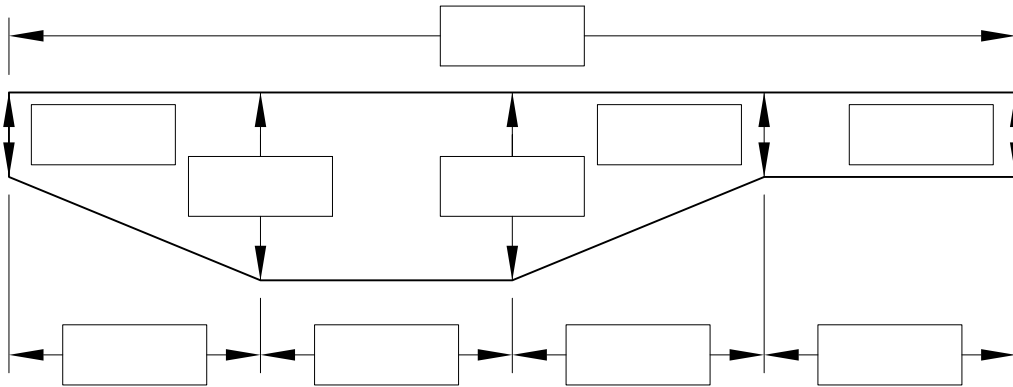

Step/Seam Location

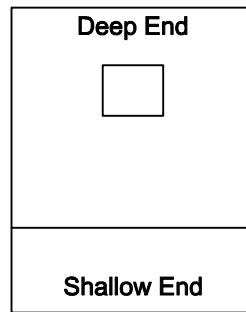

Qty Liner Needs

- | Qty | Liner Needs |
|-------|---------------------------|
| _____ | Blue Spray Glue |
| _____ | Orange Spray Glue |
| _____ | Wall Foam 1/8" |
| _____ | Wall Foam 1/4" |
| _____ | Liner Lock |
| _____ | Pool Base |
| _____ | HH66 Vinyl Adhesive |
| _____ | Duct Tape |
| _____ | 1084 Skimmer Gasket |
| _____ | 1084 Skimmer Faceplate |
| _____ | 1085 Skimmer Gasket |
| _____ | 1085 Skimmer Faceplate |
| _____ | 1408 Return Gasket |
| _____ | 1408 Return Faceplate |
| _____ | Maindrain Gasket |
| _____ | Screws SS 1" (100ct) |
| _____ | Screws SS 1 1/2" (100ct) |
| _____ | 1/4" Step Rods & Clips |
| _____ | Tek Screws |
| _____ | Liner Track (Top or Frnt) |
| _____ | Light Ring Chrm 10 Hole |
| _____ | Light Ring Gasket |

Notes:

Qty Deco-Trim

- | Qty | Deco-Trim |
|-------|--|
| _____ | Main Drain Lid & Ring <input type="checkbox"/> <input type="checkbox"/> <input type="checkbox"/> <input type="checkbox"/> <input type="checkbox"/> |
| _____ | 1084 Faceplate Cover <input type="checkbox"/> <input type="checkbox"/> <input type="checkbox"/> <input type="checkbox"/> <input type="checkbox"/> |
| _____ | 1085 Faceplate Cover <input type="checkbox"/> <input type="checkbox"/> <input type="checkbox"/> <input type="checkbox"/> <input type="checkbox"/> |
| _____ | 1408 F.P. Cover w/Eyeball <input type="checkbox"/> <input type="checkbox"/> <input type="checkbox"/> <input type="checkbox"/> <input type="checkbox"/> |
| _____ | Light Ring Hayward Outer <input type="checkbox"/> <input type="checkbox"/> <input type="checkbox"/> <input type="checkbox"/> <input type="checkbox"/> |

Color Match
 Dark Blue
 Light Blue
 Grey
 Tan

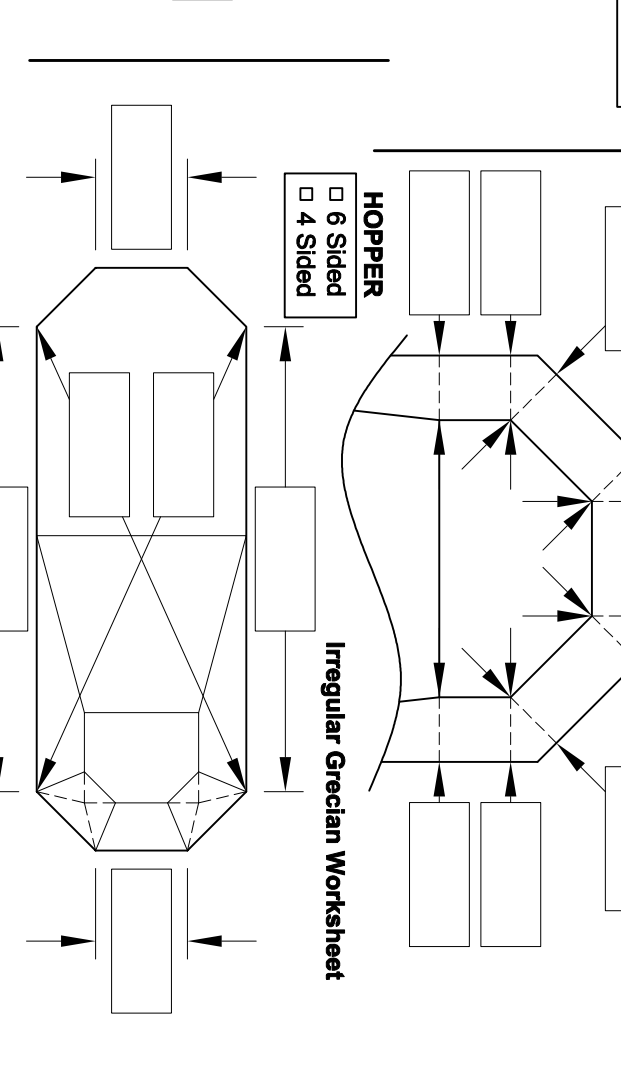
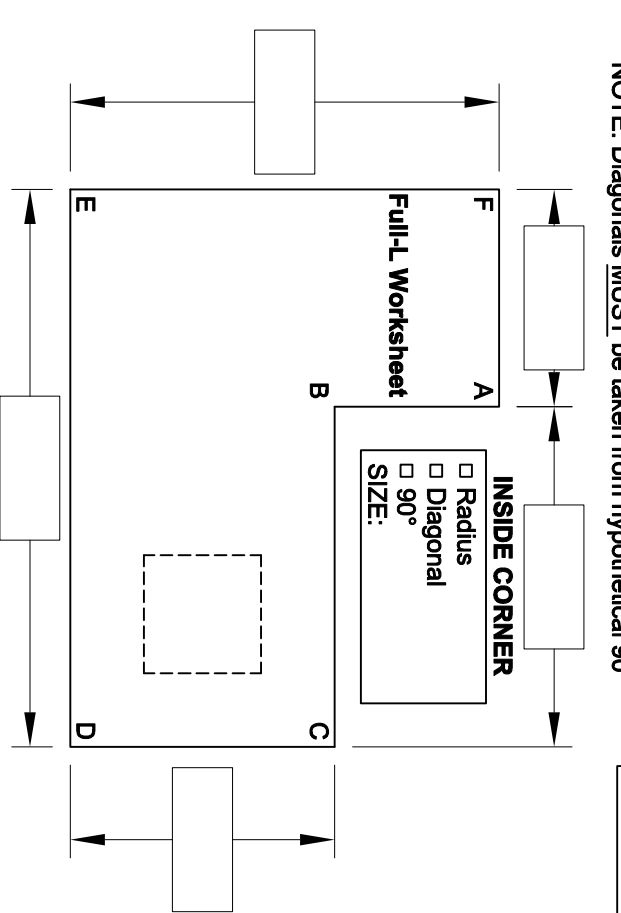
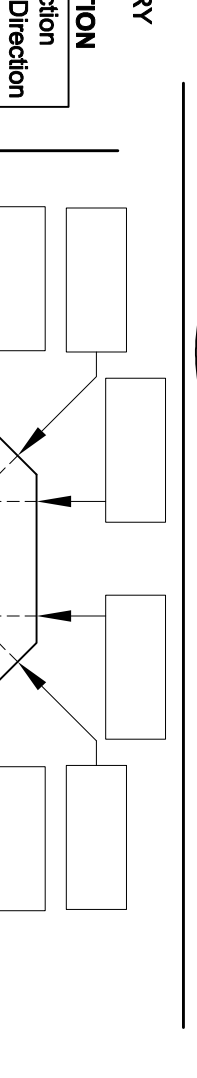
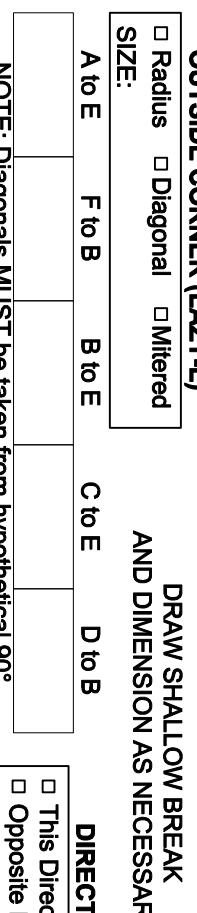
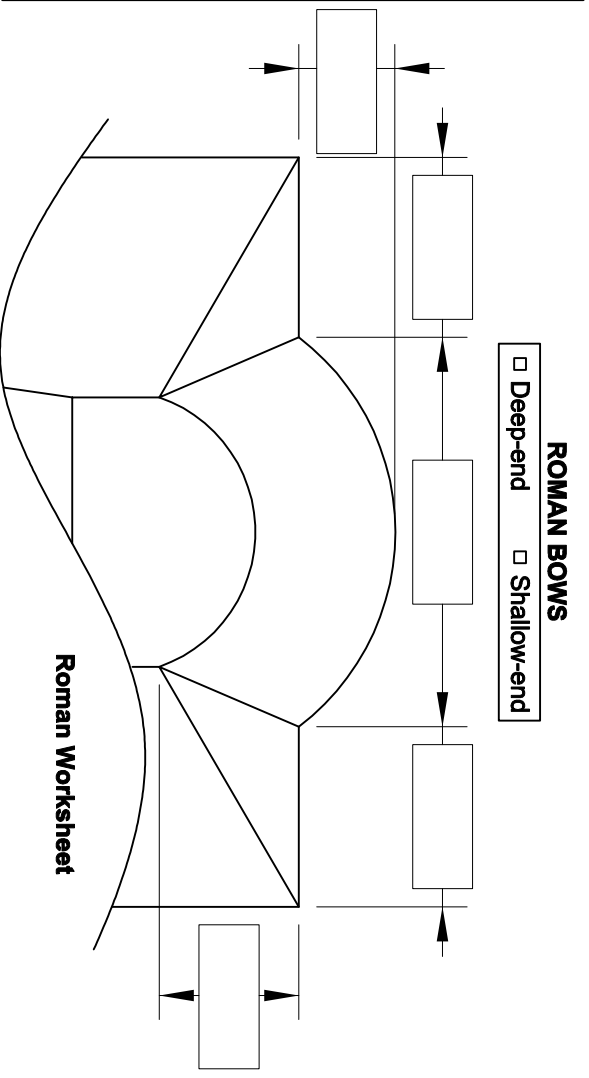
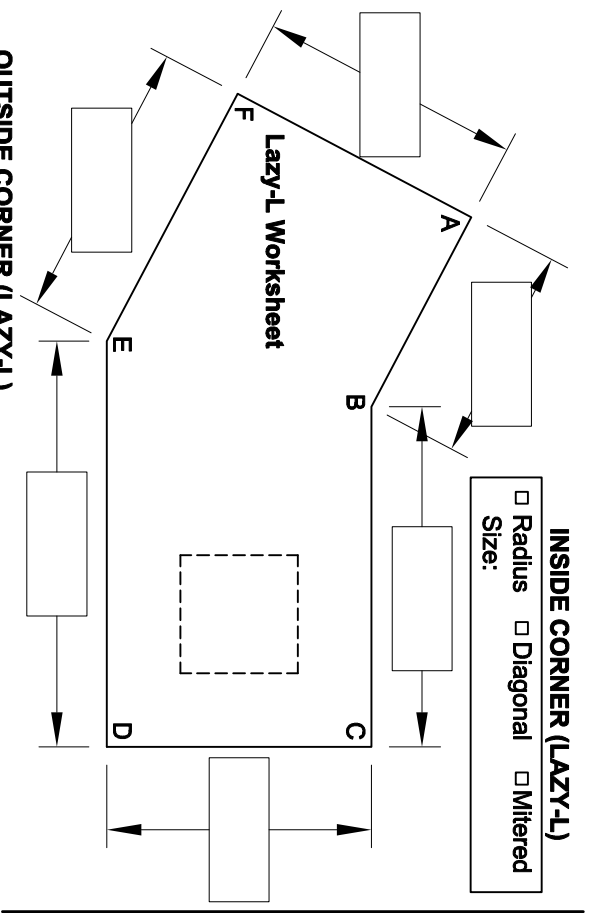

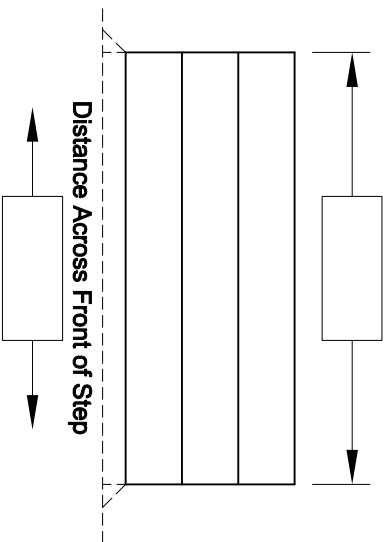

- BACK CORNERS**
- Radius
 - Diagonal
 - 90°
- Size: _____

- FRONT CORNER (LEFT)**
- Diagonal _____
 - 90° _____

- FRONT CORNER (RIGHT)**
- Diagonal _____
 - 90° _____

- RECESS**
- Recess Size: _____
- No Recess

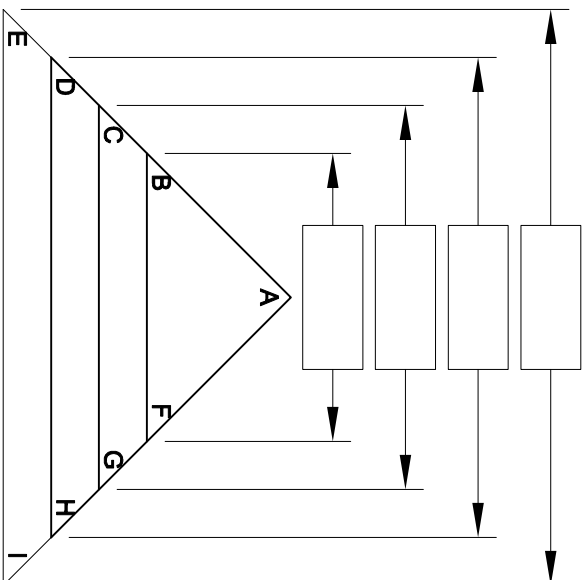
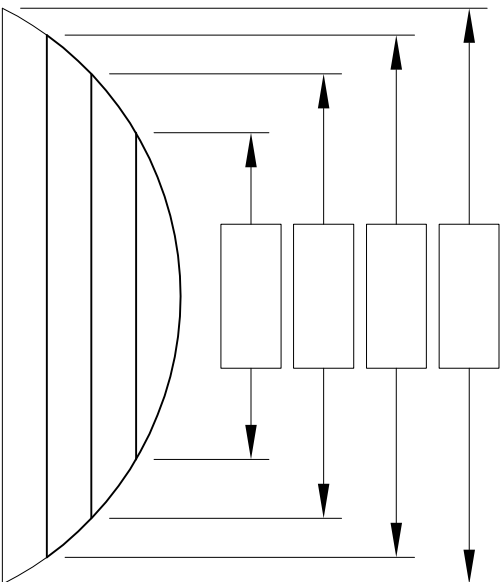

IRREGULAR CORNER STEP INFO

- | | | | |
|--------|-------|--------|-------|
| A to B | _____ | A to F | _____ |
| A to C | _____ | A to G | _____ |
| A to D | _____ | A to H | _____ |
| A to E | _____ | A to I | _____ |

NOTE: Measurements MUST be taken from hypothetical 90°

MANUFACTURED BY _____

MODEL _____

YEAR _____

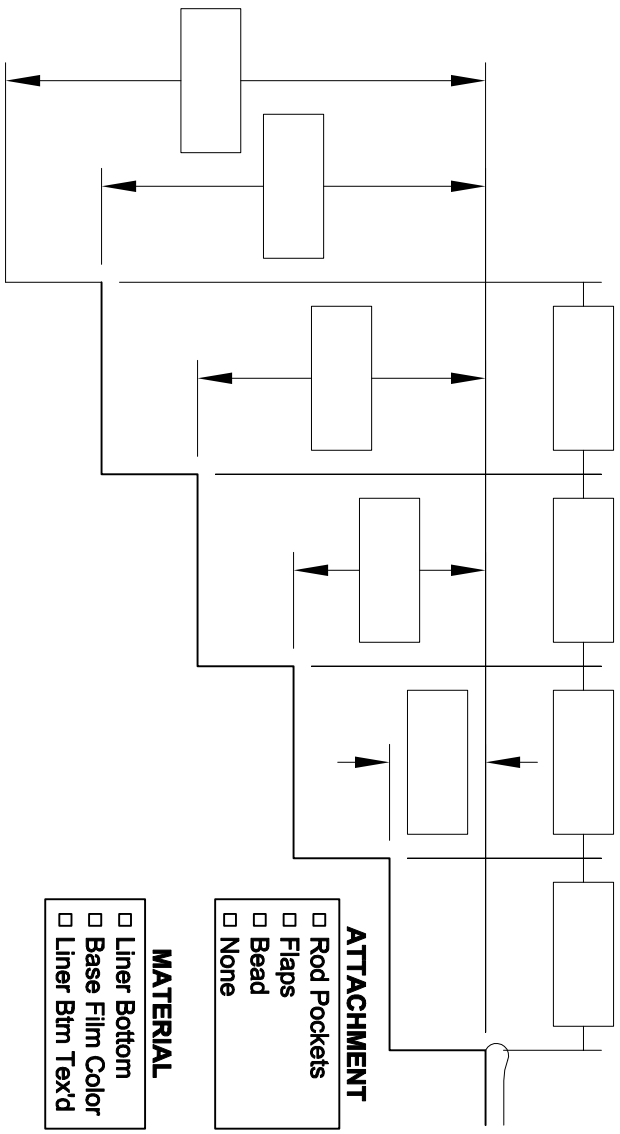

- ATTACHMENT**
- Rod Pockets
 - Flaps
 - Bead
 - None

- MATERIAL**
- Liner Bottom
 - Base Film Color
 - Liner Btm Text'd

